



Synergy<sup>®</sup> system  
Synergy UV system  
User manual





## Notice

The information in this document is subject to change without notice and should not be construed as a commitment by Millipore Corporation. Millipore Corporation assumes no responsibility for any errors that might appear in this document. This manual is believed to be complete and accurate at the time of publication. In no event shall Millipore Corporation be liable for incidental or consequential damages in connection with or arising from the use of this manual.

We manufacture and sell water purification systems designed to produce pure or ultrapure water with specific characteristics ( $\mu\text{S}/\text{cm}$ , T, TOC, CFU/ml, Eu/ml) when it leaves the water purification system provided that the Synergy Systems are fed with water quality within specifications, and properly maintained as required by the supplier.

We do not warrant these systems for any specific applications. It is up to the end user to determine if the quality of the water produced by our systems matches his expectations, fits with norms/legal requirements and to bear responsibility resulting from the usage of the water.

## Copyright

© 2011 MILLIPORE CORPORATION. PRINTED IN FRANCE. ALL RIGHTS RESERVED. THIS BOOK OR PARTS THEREOF MAY NOT BE REPRODUCED IN ANY FORM WITHOUT THE WRITTEN PERMISSION OF THE PUBLISHERS.

FTPF09574

V2.0 – 10/2011

## Trademarks

Millipore, Synergy, EDS-Pak and Elix are registered trademarks of Millipore Corporation.

Millipak and BioPak are registered trademarks of Millipore Corporation.

SynergyPak 1, SynergyPak 2, SynergyPak 3 and VOC-PAK are trademarks of Millipore Corporation.

The "M" Mark is a trademark of Merck KGaA.

All other trademarks are trademarks of their respective manufacturers.

## Product warranty and limitation of liability

The applicable warranty and limitation of liability for the products listed in this publication may be found at <http://www.millipore.com/ec/cp3/terms> within the "Terms and Conditions of Sale" applicable to your purchase transaction.



### Directive 2002/96 EC: For European users only

The symbol "crossed bin" on a product or its packaging indicates that the product should not be treated like household waste when discarded. Instead the product should be disposed of at a location that handles discarded electric or electronic equipment.

Proper disposal of equipment containing electric or electronic components will help to reduce pollution effects to the environment or to human health. Proper recycling of these products helps in environmental preservation and helps to protect natural resources. For more information about recycling of products containing electric or electronic components, please contact your local recycling representative or organisation.

## Table of Contents

<b>Introduction .....</b>	<b>1</b>
Using this Manual .....	1
Safety Information .....	1
Contacting Millipore.....	2
<b>Product Information.....</b>	<b>3</b>
Synergy System Overview .....	3
Synergy System Product Water Specifications.....	3
Schematic of Main Components.....	4
Operating principle .....	4
Technical Specifications .....	5
<b>Pre Installation .....</b>	<b>7</b>
Installation Requirements.....	7
Optional Equipment You May Need .....	7
Unpacking the Synergy System – What's Inside?.....	7
<b>Installation .....</b>	<b>9</b>
Preparation of the System .....	9
Connection of Tubing.....	9
Connection of the Power Cord – Turning on the System Power .....	11
Installation of the SynergyPak cartridge.....	12
Installation of the Tygon® Tubing.....	14
Purging Air from the System.....	15
Hydrating the System.....	15
Installation and Rinsing of the Final Filter.....	16
How to Calibrate the Flowrate from the Synergy System (F02).....	17
How to Show Resistivity or Conductivity Units (C01).....	19
How to Set the Resistivity Setpoint (C02).....	20
<b>Using the Synergy System .....</b>	<b>21</b>
Understanding the Display.....	21
How to Get Water from the Synergy System.....	21
How to Dispense an Exact Amount of Product Water (F01).....	22
Operating Modes .....	23
How to view the Product Resistivity and Temperature in Pre Operate mode.....	25
How to recirculate water manually before dispensing .....	25
How to Understand Synergy System messages.....	26

**Maintenance..... 27**  
Maintenance Schedule..... 27  
In order to maintain good performance of your water system respect the maintenance schedule and replace consumables as required. .... 27  
How to Replace the SynergyPak cartridge ..... 28  
How to Replace the Final Filter..... 31  
How to Clean the Screen Filter..... 32  
How to Replace the UV Lamp (UV System only) ..... 33  
How to View or Reset the UV Lamp Timer (C03) ..... 36  
**Troubleshooting..... 39**  
**Ordering Information ..... 41**  
Catalogue Numbers for Synergy Systems ..... 41  
Catalogue Numbers for Consumables..... 41  
Catalogue Numbers for Accessories ..... 41

### Using this Manual

This User Manual is a guide for use during the installation, normal operation and maintenance of a Synergy System or Synergy UV Water Purification System. 'Synergy' is used in this manual to refer to either the Synergy or the Synergy UV System unless otherwise noted. It is highly recommended to completely read this manual and to fully comprehend its contents before attempting normal operation or maintenance of the Water Purification System.

### Safety Information

Your Synergy System should be operated according to the instructions in this manual. In particular, the hydraulic and electrical specifications should be followed and met. It is important to use this equipment as specified in this manual; using this equipment in a different manner may impair the safety precautions of the Synergy System.

#### Symbol

#### What it means



This HAZARD symbol is used to refer to instructions in this manual that need to be done safely and carefully.



This ATTENTION symbol is used to refer to instructions in this manual that need to be done carefully.



This UV RADIATION sticker is used to refer to a position on the system cabinet or inside of it where exposure to UV light is possible.



This DANGER sticker is used to refer to a position on the system cabinet or inside of it that could be hazardous.



This ELECTRICAL GROUND sticker is used to refer to a position on the system cabinet or inside where an electrical ground connection is made.



This ELECTRICAL DANGER sticker is used to refer to a position on the system cabinet or inside where an electrical danger could exist.

## **Introduction**

## **Contacting Millipore**

### **Internet**

The Millipore Internet Site can be used to find addresses, telephone/fax numbers and other information.

Internet Site Address: [www.millipore.com](http://www.millipore.com)  
[www.millipore.com/techservice](http://www.millipore.com/techservice)

### **Manufacturing Site**

Millipore SAS  
67120 Molsheim  
FRANCE



## Synergy System Overview

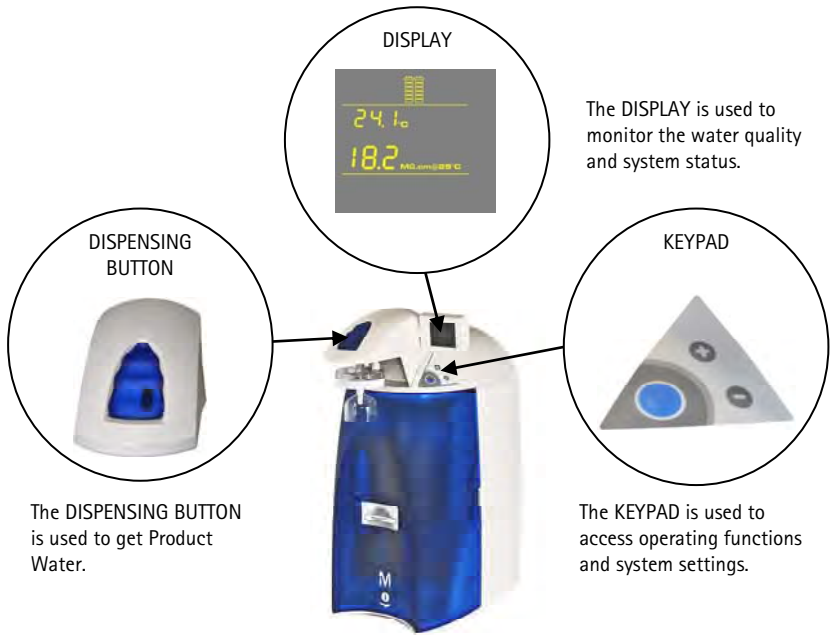

## Synergy System Product Water Specifications

### Water Flowrate Specifications

Up to 1.5 LPM (with Final Filter)
-----------------------------------

### Product Water Quality

Resistivity	18.2 MΩ.cm @ 25 °C
Total Organic Carbon (TOC)	< 5 µg/L (ppb) (with UV) < 10 µg/L (ppb) (without UV)
Micro-Organisms	< 0.1 CFU/ml (with Final Filter)

## Product Information

### Schematic of Main Components

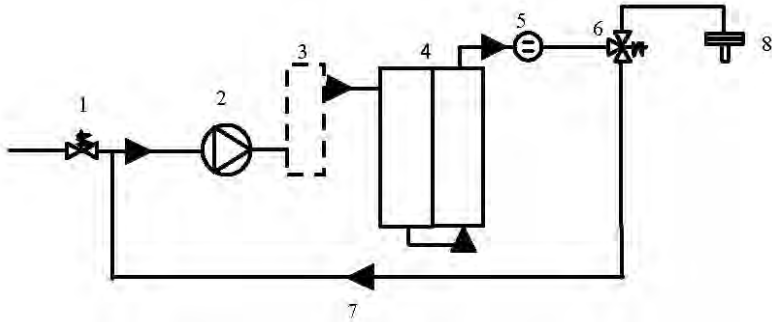

- 1 Inlet Solenoid Valve
- 2 Booster Pump
- 3 UV Lamp 185 nm (UV System)
- 4 SynergyPak 1, 2 or 3

- 5 Product Resistivity Cell
- 6 Point-of-Use (POU) Solenoid Valve
- 7 Recirculation Loop
- 8 Final Filter

### Operating principle

The Synergy Water Purification System is fed with pretreated water (Elix<sup>®</sup>, RO, distilled or DI water) coming from a tank or a loop.

When Product Water is being dispensed, the Inlet Solenoid Valve opens and the Booster Pump turns on. The pretreated water is then pumped into the UV Lamp (UV System). The UV Lamp emits light at 185 nm and 254 nm. It is used to reduce levels of organic molecules in the water. The UV Lamp is a consumable device that needs to be periodically replaced during the maintenance of the system. The water is then sent to the SynergyPak cartridge to deionize the water. There are three types of SynergyPak cartridge. SynergyPak 1 is used for RO, distilled or Elix feedwater. SynergyPak 2 is used for pretreated water from clean DI (particulate-free). SynergyPak 3 is used for pretreated water from dirty DI (non particulate-free). The SynergyPak cartridge is a consumable device that needs to be periodically replaced during the maintenance of the system.

The Final Filter is a membrane based filter that removes all particles and bacteria with a size greater than the filter pore size. The Final Filter is a consumable device.

## Technical Specifications

### Dimensions

#### System Height, Width and Depth

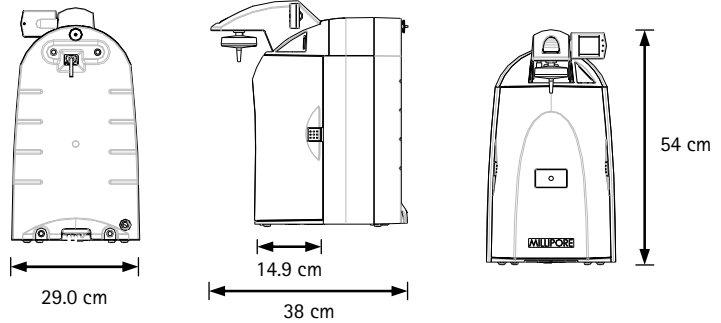

#### Shipping Box

- Height: 56 cm
- Width: 42 cm
- Depth: 64 cm

### Weight

System	Synergy	Synergy UV
Operating Weight	8.8 kg	9.4 kg
Dry Weight	5.3 kg	5.9 kg
Shipping Weight	9.5 kg	10.1 kg

### Noise Level

A Synergy System has a maximum noise level of 36 dB at a distance of 1 metre away.

### Electrical

- 100 VAC  $\pm$  10%, 50/60 Hz. 0.56 amp source, 2 amp T (Time Lag) fuse, Power = 56 VA
- 120 VAC  $\pm$  10%, 50/60 Hz. 0.56 amp source, 2 amp T fuse, Power = 56 VA
- 230 VAC  $\pm$  10%, 50/60 Hz. 0.31 amp source, 2 amp T fuse, Power = 77 VA



The source of electrical power should be within 2.5 metres of the system. The source of electrical power must be earth grounded.



## Installation Requirements

### Feedwater Requirements

Type of Feedwater	Elix, RO, distilled or DI water
Flowrate	≥ 1.5 LPM (Litres per minute)
Minimum Pressure	> 0 bar (Feed from a tank)
Maximum Pressure	≤ 0.5 bar
Temperature	5 to 35 °C
Conductivity	< 100 µS/cm
TOC	< 50 ppb

**NOTE:**

*If the feedwater pressure is greater than 0.5 bar, then the Pressure Regulator (ZFMQ000PR) is required.*

### Feedwater Connection Needed

Feedwater Piping Connection	1/2 inch Male GAZ, NPTM or BSPM
-----------------------------	---------------------------------

### Environmental Requirements

Indoor Use Only	
Storage Temperature	5 °C < T < 40 °C
Operating Temperature	5 °C < T < 40 °C
Relative Humidity	Should not exceed 80% for temperatures below 31 °C Should stay within 50% to 80% between 31 °C and 40 °C.
Altitude	< 3000 metres
Installation Category	II
Pollution Degree	2

## Optional Equipment You May Need

### Wall Mounting Bracket

The Millipore Catalogue Number for the Wall Mounting Bracket is WMBSMT002. The mounting hardware for attaching the bracket to a wall is not included and must be supplied.

## Unpacking the Synergy System – What's Inside?

Open the Synergy System Shipping Box. Use the checklist included in the Accessories Bag to make sure all items were shipped and are accounted for. It is highly suggested to become familiar with the items that are shipped since these will be used in the Installation section of this manual.

*Contact Millipore if an item is missing.*



### Preparation of the System



- Open the front cover.  
(this may require to remove the final filter)  
Locate the tie wrap used to hold the Booster Pump in place during shipping (A).



- Press on the tab of the tie wrap (B).  
Remove and pull the tie wrap out.



- Locate the protective foam found at the UV lamp cable.  
Remove it (C).

### Connection of Tubing



- Rotate the Synergy System so you can see the back of the system  
(see photo A).

← Feedwater tubing

# Installation

## Feedwater Tubing

B



- 
- Locate the Feedwater Tubing exiting from the bottom of the system (B).  
A 1/2 inch Female GAZ fitting with a screen filter is attached at the end of this tubing.  
Unroll it until the fitting reaches the Feedwater source.

C



- Apply white tape on the thread of the 1/2 inch Male GAZ valve or fitting of the Feedwater source.
- 
- Connect the fitting to the valve (C).
-



## Connection of the Power Cord – Turning on the System Power

---



- Open the front cover of the system (A).  
(this may require to remove the final filter)  
This will allow the system to go into STANDBY mode once the system is powered.
- 



- Plug the Power Cord into the system (B).
  - Plug the other end of the Power Cord into an appropriate source of electrical power (i.e. wall outlet).  
The system is immediately powered.
  - Open the Feedwater Supply Valve.
- 

## Start-up Displays

---



- Once the system is powered, the system will start to display information about the software before going into STANDBY mode (C).
-

## Installation

### Installation of the SynergyPak cartridge



Do not touch the UV Lamp when replacing the SynergyPak cartridge.

### Installation

A

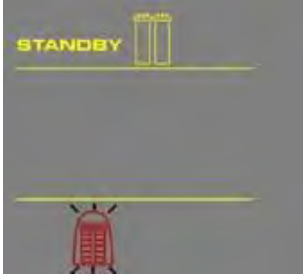

- 
- Make sure the front cover is opened. STANDBY should be viewed on the Display (A).
  - Remove the SynergyPak cartridge from its shipping box.
  - Remove the protective caps on the ports of the SynergyPak cartridge and from the system.

B



- 
- Locate the O-rings on the ports (B). Wet them with water. It is preferable to wet them with ultrapure water.

## Installation

C



- Install the SynergyPak cartridge until it is fully seated into the system ports as shown (C, D).

D



E



- CLOSE THE FRONT COVER.

## Installation

### Installation of the Tygon® Tubing



Do not use any white tape on the threads of the Barbed Fitting. An O-ring is located inside the POU Dispenser to ensure water tightness between the threads of the POU Dispenser and the Barbed Fitting.

---



- Locate the clear Tygon Tubing and the Barbed Fitting from the Accessories Bag.
  - Screw the Barbed Fitting onto the bottom end of the POU Dispenser (A).
- 



- Push one end of the Tygon Tubing onto the end of the Barbed Fitting (B). Place the other end of the Tygon Tubing in a sink.
-

### Purging Air from the System

A



- 
- At this time you should have installed the SynergyPak cartridge, Barbed Fitting and the Tygon Tubing. Air trapped in the SynergyPak cartridge should now be purged from the system.
  - Press the Dispensing Button once to put the system into DISPENSING mode (A).
  - Dispense about 3-4 Litres of water from the system.
- 

### Hydrating the System

- 
- At this time, the Final Filter is not installed. Leave the system overnight or for several hours in PRE OPERATE mode (*see Section Operating Modes*). The system will regularly recirculate water and rinse off purification media inside the SynergyPak cartridge. Do not leave the system in STANDBY mode.
  - (The next morning) Press the Dispensing Button once to put the system into DISPENSING mode.
  - Allow about 1 Litre of water to be dispensed from the system.
  - Press the Dispensing Button once again. The system will finish dispensing water.
  - Remove the Tygon Tubing and the Barbed Fitting from the POU Dispenser.
  - The Final Filter needs to be installed.  
(*See Section Installation and Rinsing of the Final Filter*).
-

## Installation

### Installation and Rinsing of the Final Filter

---

A



- Obtain a Final Filter. It can be the Millipak® Express 20 or the BioPak® Ultrafiltration Cartridge.
  - Remove the Tygon Tubing and the Barbed Fitting from the POU Dispenser.
  - Screw the Final Filter onto the end of the POU Dispenser. The Final Filter should be turned until it is hand tight (A). Do not over tighten the Final Filter.
- 



**ATTENTION**

**Do not use white tape on the threads of the Final Filter. The POU Dispenser has an O-ring inside which provides a watertight seal.**

---

B



- Press the Dispensing Button once. This will bring the system into DISPENSING mode.
  - Locate the air vent valve (not present on all types of Final Filters) on the top side of the Final Filter. Open this slowly but do not remove it.(B). Allow any air on the clear side of the Final Filter to be vented out.
- 



**ATTENTION**

**Air will not pass through the membrane filter in the Final Filter. If there is trapped air, then a reduction in Product Water flowrate can result.**

---

- Dispense about 1 Litre of water. Make sure all air is purged out.
  - Press the Dispensing Button once again. The system will finish dispensing water.
  - Leave the system in PRE OPERATE mode.
- 



**ATTENTION**

**It is highly recommended not to put Tygon Tubing or any other type of tubing on the end of the Final Filter. This can compromise the Product Water quality (bacteria can grow in the Tygon Tubing).**

---

- The Water System is now ready for use.
-

## How to Calibrate the Flowrate from the Synergy System (F02)

Before calibrating the Product flowrate from the Synergy System, you will need a 1 Litre graduated cylinder to measure the total volume of water that will be dispensed. The Final Filter should be installed.

1



Press the Main and "-" Buttons together to enter the menu. The Display will show F01.



2



Press the Main Button once. The Display will show F02 and the 60 second timer. The graduated cylinder will be blinking.



3



Press the Dispensing Button once. The system will dispense water for 60 seconds. The Display will show the timer counting down.



Continued on next page

## Installation

- 4 Measure the total volume of water (in Litres) dispensed from the system using a 1 L graduated cylinder.

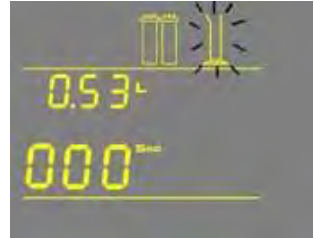

- 5 Press the "+" or "-" Button to match the volume Display to the volume measured.



- 6 To exit the menu, press and hold the Main Button for 2 seconds.



To display the next menu option, press the Main Button once.











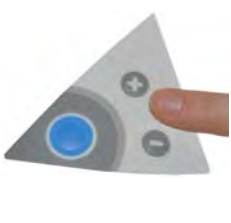

## How to Show Resistivity or Conductivity Units (C01)

### With Temperature Compensated or non Temperature Compensated values

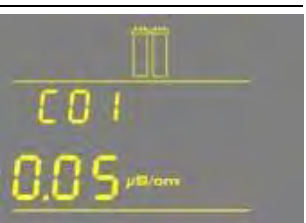
Temperature compensation is a way of 'standardizing' Resistivity or Conductivity to measurements that would be seen if the water temperature was 25 °C.

- |  |   |  |
|--|---|--|
| <p>1</p>    | <p>Press the Main and "+" Buttons together to enter the menu. The Display will show C01 and the units chosen. The following Display shows Temperature Compensated Resistivity Units: <math>M\Omega.cm @25\ ^\circ C</math>.</p> |    |
| <p>2</p>    | <p>Press the "+" or "-" Button to select Non Temperature Compensated Resistivity Units: <math>M\Omega.cm</math>.</p>  |    |
| <p>3</p>    | <p>Press the "+" or "-" Button to select Temperature Compensated Conductivity Units: <math>\mu S/cm @25\ ^\circ C</math>.</p>   |    |
| <p>4</p>   | <p>Press the "+" or "-" Button to select Non Temperature Compensated Conductivity Units: <math>\mu S/cm</math>.</p>   |   |
| <p>5</p>  | <p>To exit the menu, press and hold the Main Button for 2 seconds.<br/>To display the next menu option, press the Main Button once.</p>   |  |

# Installation

## How to Set the Resistivity Setpoint (C02)

The Resistivity Setpoint is used to inform you when the Product resistivity is low. When the resistivity is below the setpoint, the Resistivity display will flash and the red Pack Alarm will be blinking (see *Section How to Understand Synergy System* messages). The factory default resistivity value is set to 15 MΩ.cm @25 °C.



Press the Main and "+" Buttons together to enter the menu. The Display will show C01.



Press the Main Button once. The Display will show C02 and the Resistivity Setpoint value.



Press the "+" or "-" Button to adjust the Resistivity Setpoint from 1.0 MΩ.cm @25 °C to 18.0 MΩ.cm @25 °C.



If Conductivity Units are chosen in C01, then the Setpoint can be adjusted from 0.999 μS/cm @25 °C to 0.055 μS/cm @25 °C.

**NOTE:**

*The Conductivity Setpoint display needs to be multiplied by 0.001 to get the real value. For example, if the Display reads "055" μS/cm @25 °C, then you would multiply 055 x 0.001 = 0.055. Thus, the real Conductivity Setpoint reading is 0.055 μS/cm @25 °C.*



To exit the menu, press and hold the Main Button for 2 seconds.

To display the next menu option, press the Main Button once.

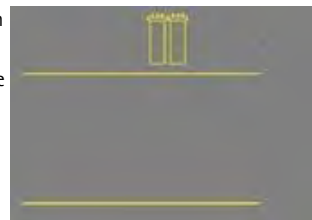

### Understanding the Display

The Display is used to view information about the Operating Modes, the Operating Parameters and Maintenance or Alarm messages.

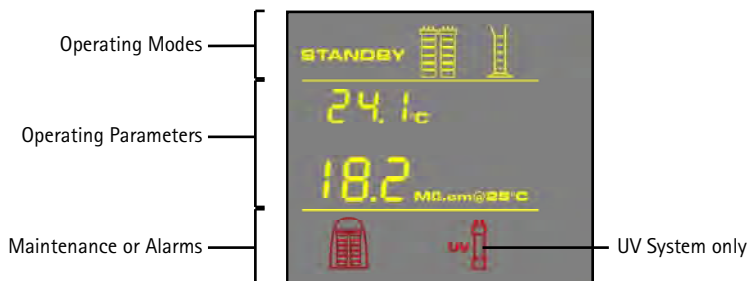

### How to Get Water from the Synergy System

#### Using the Dispensing Button

There are two ways to get water using the Dispensing Button:

Press once and release.



To stop dispensing water, press the Dispensing Button once again.

OR

Press and hold down.



To stop dispensing water, release the Dispensing Button.

# Using the Synergy System

## How to Dispense an Exact Amount of Product Water (F01)

- 1 Press the Main and "-" Buttons together to enter the menu. The Display will show F01.



- 2 Press the "+" or "-" Button to adjust the exact amount of Product Water (in Litres) needed. Pre-set volumes of water can be adjusted from 0.25 L to 9.75 L in 0.25 increments.



**NOTE:**

*The accuracy of this is dependent upon the accuracy of the Flow Calibration performed in Section How to Calibrate the Flowrate from the Synergy System.*

- 3 Press the Dispensing Button once. The system will dispense water. The Display will show the amount of water dispensed and the Product resistivity.



**NOTE:**

*To stop dispensing water, press the Dispensing Button once again.*

- 4 To exit the menu, press and hold the Main Button for 2 seconds. To display the next menu option, press the Main Button once.

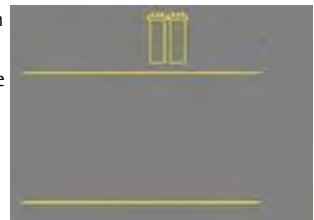

**Operating Modes**

---

**Standby**

STANDBY mode is displayed when the front cover is removed. The system will depressurize during which STANDBY will be blinking on the Display for 10 seconds. All system operations are disabled. STANDBY mode is selected before attempting maintenance on the system.



**Pre Operate**

PRE OPERATE mode is displayed when the system is not dispensing water and not in Standby mode.



The system will have a 3-minute auto-recirculation every 2 hours in PRE OPERATE mode. The Booster Pump turns on. This will enhance the quality of the Product Water delivered from the system. Recirculation can also be activated manually for up to 3 minutes.



The resistivity and temperature of the Product Water is displayed during recirculation. The resistivity and temperature remain displayed for up to 10 seconds after recirculation is finished.

---

## Using the Synergy System

---

### Dispensing

DISPENSING mode is displayed when Product Water is being dispensed. DISPENSING mode occurs because the Dispensing Button was pressed down. The Booster Pump turns on.



The resistivity and temperature of the Product Water is displayed during dispensing. The resistivity and temperature remain displayed for up to 10 seconds after dispensing is stopped.



### Auto-Dispensing

AUTO-DISPENSING mode is displayed when selecting menu option F01. AUTO-DISPENSING mode is used to dispense pre-set volumes of water from the Synergy System.

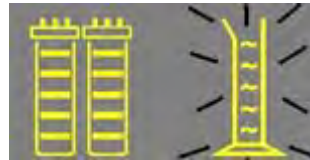

The amount of water dispensed and the resistivity are shown while water is being dispensed. The resistivity remains displayed for up to 10 seconds after dispensing is stopped.

---

### How to view the Product Resistivity and Temperature in Pre Operate mode

---

**Press:**



The Display will show the last Product resistivity and temperature values measured during DISPENSING mode or during RECIRCULATION. The values are displayed for 5 seconds.



**NOTE:**

*The Product resistivity and temperature are displayed automatically during DISPENSING mode or during RECIRCULATION.*

---

### How to recirculate water manually before dispensing

This option is used to enhance the quality of the Product Water before dispensing water. The Booster Pump will turn on and water will recirculate for up to 3 minutes. An auto-recirculation occurs for 3 minutes every 2 hours.

**Press:**



The Display will show the Product resistivity and temperature.



**NOTE:**

*To dispense water, press the Dispensing Button during recirculation. Recirculation will stop and water will be dispensed.*

---

# Using the Synergy System

## How to Understand Synergy System messages

### Pack Alarm

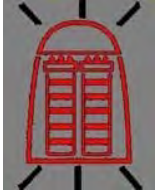

- 
- The system will prompt you to change the SynergyPak cartridge using a red Pack Alarm icon. The Display will show the red Pack Alarm blinking. The SynergyPak cartridge is changed due to either the amount of time it has been used or from the amount of water that has passed through it.



- 
- When the Resistivity display is blinking, the red Pack Alarm will also be blinking. This indicates that the SynergyPak cartridge should be replaced. This message is shown when the Product resistivity is less than the Resistivity Setpoint. The Resistivity Setpoint can be seen in menu option C02.



- 
- When the red Pack Alarm is displayed as a steady icon, the SynergyPak cartridge is not installed correctly or not installed at all. If the SynergyPak cartridge has been reinstalled and the Alarm is still displayed, then contact Millipore.

### UV Lamp Alarm

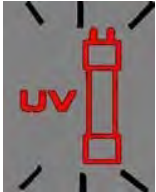

- 
- The system will prompt you to change the UV Lamp using a red UV Lamp Alarm icon. The Display will show the red UV Lamp Alarm blinking. The message is shown when the UV Timer displays 0 days. The UV Timer can be viewed in menu option C03. The replacement of the UV Lamp involves the installation of a new UV Lamp and a manual reset of the UV Timer.





- 
- When the red UV Lamp Alarm is displayed as a steady icon, the UV Lamp is not installed correctly or not installed at all. If the UV Lamp has been reinstalled and the Alarm is still displayed, then contact Millipore.
-



## Maintenance Schedule

In order to maintain good performance of your water system respect the maintenance schedule and replace consumables as required.

What to do	When?	How to?
<p>SynergyPak cartridge Replacement</p>	<p>When the Pack Alarm display is blinking.</p>  <p>When the system resistivity display is blinking.</p> 	<p>See Section How to Replace the SynergyPak cartridge</p>
<p>Final Filter Replacement</p>	<p>The Final Filter is replaced when the SynergyPak cartridge is replaced or when the Product Water flowrate drops.</p>	<p>See Section How to Replace the Final Filter</p>
<p>Flow Calibration</p>	<p>When the Final Filter is replaced, or periodically.</p>	<p>See Section How to Calibrate the Flowrate from the Synergy System</p>
<p>UV Lamp Replacement and UV Timer Reset</p>	<p>When the UV Lamp Alarm display is blinking.</p> 	<p>See Section How to Replace the UV Lamp (UV System only) and How to View or Reset the UV Lamp Timer (C03)</p>
<p>Screen Filter Cleaning</p>	<p>2 times a year or as necessary.</p>	<p>See Section How to Clean the Screen Filter</p>

## Maintenance

### How to Replace the SynergyPak cartridge



Do not touch the UV Lamp when replacing the SynergyPak cartridge.

#### Removing the SynergyPak cartridge

A



- Open the front cover (this may require to remove the final filter) to go into STANDBY mode.  
Press the Dispensing Button once.  
The system will dispense water.  
Wait for the system to depressurize.  
The Display will show STANDBY blinking for 10 seconds.
- Remove the Final Filter.

B



- Press your thumbs on the system and swing the pack towards you

C



- Remove the pack from the system (C).

### Installation

D



- Remove the new SynergyPak cartridge from its shipping box.
  - Remove the protective caps on the ports of the SynergyPak cartridge.
  - Locate the O-rings on the ports. Wet them with water. It is preferable to wet them with ultrapure water.
  - Install the SynergyPak cartridge until it is fully seated into the system ports as shown (D, E and F).
- 

E



F



- **CLOSE THE FRONT COVER.**
-

## Maintenance

### Installing the Tygon Tubing

G

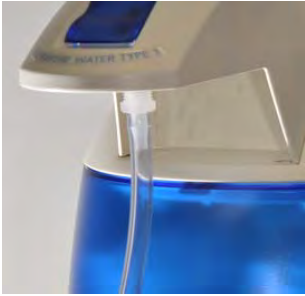

- 
- Install the Barbed Fitting and Tygon Tubing (G).  
(See Section *Installation of the Tygon® Tubing*).
- 

### Purging Air from the System

- 
- (See Section *Purging Air from the System*).
- 

### Hydrating the System.

H



- Hydrate the system (H).  
(See Section *Hydrating the System*).
  - Replacing the Final Filter
- 

I



- See Section *How to Replace the Final Filter* (I).
- 

The System is now ready for use.

---

## How to Replace the Final Filter

The Final Filter is normally replaced when the SynergyPak cartridge is replaced or at an earlier time if it becomes clogged. A clogged Final Filter can reduce the Product Water flowrate.



**ATTENTION**

**Make sure the SynergyPak cartridge has been hydrated overnight.**

A



- Remove the used Final Filter.
- Screw the new Final Filter onto the end of the POU Dispenser. The Final Filter should be turned until it is hand tight (A). Do not over tighten the Final Filter.



**ATTENTION**

**Do not use white tape on the threads of the Final Filter. The POU Dispenser has an O-ring inside which provides a watertight seal.**

B



- *(If your Final Filter is a Millipak)* Locate the air vent valve on the top side of the Millipak. Open this slowly but do not remove it from the Millipak (B). Allow any air on the clear side of the Millipak to be vented out.



**ATTENTION**

**Air will not pass through the membrane filter in the Millipak. If there is trapped air in the Millipak, then a reduction in Product Water flowrate can result.**

- Dispense about 1 Litre of water. Make sure all air is purged out.
- Press the Dispensing Button once again. The system will finish dispensing water.
- Leave the system in PRE OPERATE mode.

The Water System is now ready for use.

**At this time, it is highly recommended to recalibrate the Product Water flowrate. See Section How to Calibrate the Flowrate from the Synergy System.**

## Maintenance

### How to Clean the Screen Filter

The purpose of the Screen Filter is to prevent large particles or other debris from entering the system. If the Screen Filter becomes blocked with debris, then the Feedwater will not flow freely to the system.

It is recommended to clean the Screen Filter twice a year or whenever it may have become clogged.

A



- Close the Feedwater Supply Valve.
- Open the front cover (this may require to remove the final filter) to let the system go into STANDBY mode.
- Locate the Screen Filter. This will be located where the Feedwater 8 mm OD Tubing originates.
- Unscrew the collar that holds the Feedwater Tubing to the barbed end of the fittings (A). Pull the tubing off of the fitting.
- Unscrew the Screen Filter from the Feedwater pipe.

B



- Go to a sink and flush tap water backwards through the Screen Filter. The water should flow through the barbed end first. Any trapped debris on the Screen Filter will be flushed out (B).
- Apply 3-4 turns of new white tape to the threads of the Feedwater Pipe in a clockwise direction.
- Screw the Screen Filter back onto the Feedwater Supply Pipe.

C



- Attach the Feedwater Tubing back onto the Barbed Fitting (C).
- Open the Feedwater Supply Valve.
- Close the front cover.
- Leave the system in PRE OPERATE mode.

## How to Replace the UV Lamp (UV System only)

The red UV Lamp Alarm will be blinking on the Display when it is time to exchange the UV Lamp. The message is shown when the UV Timer has reached 0 days (see *Section How to View or Reset the UV Lamp Timer (C03)*).



No electrical power should be going to the system at this time. Accidental exposure to ultraviolet light can cause damage to the eyes and skin.



- Open the front cover (this may require to remove the final filter) to go into STANDBY mode (A).

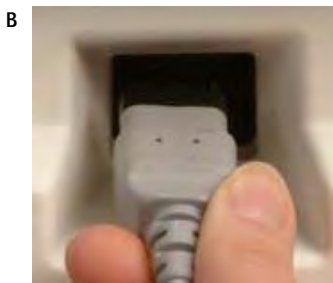

- Unplug the electrical cord to power OFF the system (B).
- Remove the Final Filter.



- Remove the SynergyPak cartridge (C).

## Maintenance

### Removing the UV Lamp



The UV Lamp contains metallic Mercury. Please dispose of the used UV Lamp in a manner that is environmentally safe.



- Detach the Velcro® belt of the UV housing.
- Pull the UV housing out so that the UV Lamp cable is accessible (D).

*NOTE:*

*Use the gloves supplied with the UV replacement kit.*

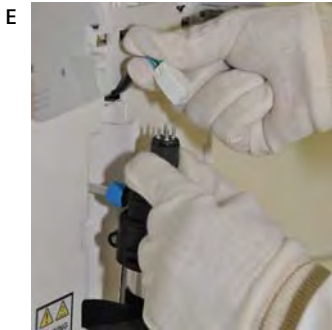

- Unplug the electrical cable from the UV Lamp (E).

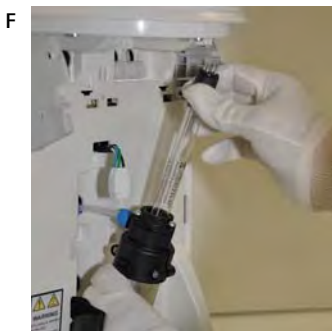

- Pull the UV Lamp out of the UV housing by its electrical cable (F).



## Installing the new UV Lamp

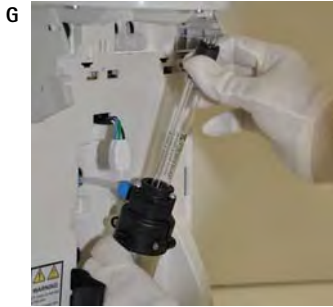

- Carefully insert the UV Lamp into the UV housing (G).



- Ensure that you use the gloves supplied with the UV replacement kit. Plug the electrical cable to the new UV Lamp (H).



- Attach the UV housing with the Velcro belt (I).



- Install the SynergyPak cartridge (J).
- Install the Final Filter.
- Close the front cover.
- Plug the electrical cord to power ON the system.
- Reset the UV Timer.  
*(See Section How to View or Reset the UV Lamp Timer (C03)).*

## Maintenance

### How to View or Reset the UV Lamp Timer (C03)

The UV Lamp Timer should be reset only after the UV Lamp has been replaced (*see Section How to Replace the UV Lamp (UV System only)*). The UV Lamp Timer displays the time left until the UV Lamp needs to be replaced. The Display will show the red UV Lamp Alarm icon blinking when the Timer reaches 0 days. This message is displayed until the UV Lamp is replaced and the UV Lamp Timer is reset.

#### How to View the Remaining Days on the UV Lamp Timer

- 1 Press the Main and "+" Buttons together to enter the menu. The Display will show C01.



- 2 Press the Main Button 2 times. The Display will show C03 and the days left on the UV Timer.



- 3 To exit menu, press and hold the Main Button for 2 seconds.  
To display the next menu option, press the Main Button once.



## How to Reset the UV Lamp Timer

1



- Press the Main and "+" Buttons together to enter the menu. The Display will show C01.



2



- Press the Main Button 2 times. The Display will show C03 and "0" days left on the UV Timer.



3



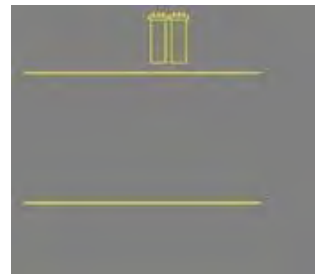

- Press the "+" and "-" Buttons together. This will reset the UV Timer to 500 (days). The Display will exit the menu.





The UV Timer has been reset.

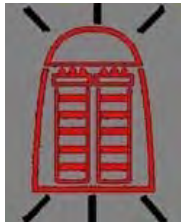

## Troubleshooting

Problem	Possible causes	What to do
The Display screen is blank.	<ul style="list-style-type: none"> <li>• The power cord is not plugged in.</li> <li>• No source of electrical power.</li> <li>• Main Power Fuse is blown.</li> </ul>	<ul style="list-style-type: none"> <li>• Check that the power cord is plugged in.</li> <li>• Check the source of electrical power.</li> <li>• Contact Millipore.</li> </ul>
Low water flow or no water flow when the Dispensing Button is pressed.	<ul style="list-style-type: none"> <li>• Millipak Filter is air locked.</li> <li>• Final Filter is clogged.</li> </ul>	<ul style="list-style-type: none"> <li>• Vent all air from the Millipak Filter.</li> <li>• Replace the Final Filter, see <i>Section How to Replace the Final Filter.</i></li> </ul>
AUTO-DISPENSING mode is not accurate.	<ul style="list-style-type: none"> <li>• The Product Water flowrate is not calibrated.</li> <li>• The Final Filter is clogged or airlocked.</li> </ul>	<ul style="list-style-type: none"> <li>• Calibrate the Product Water flowrate. See <i>Section How to Calibrate the Flowrate from the SynergySystem.</i></li> <li>• Replace the Final Filter.</li> </ul>
The last Product resistivity value is not displayed when you press the "-" button in PRE OPERATE mode.	<ul style="list-style-type: none"> <li>• A measurement was not made during DISPENSING mode or during recirculation.</li> <li>• The value is out of measurement range.</li> </ul>	<ul style="list-style-type: none"> <li>• Dispense or recirculate water manually to start a Product resistivity reading again.</li> </ul>
	<ul style="list-style-type: none"> <li>• The SynergyPak cartridge lifetime is exhausted.</li> <li>• The Product resistivity is less than the Resistivity Setpoint set in menu option C02.</li> </ul>	<ul style="list-style-type: none"> <li>• Replace the SynergyPak cartridge. See <i>Section How to Replace the SynergyPak cartridge.</i></li> </ul>
	<ul style="list-style-type: none"> <li>• The SynergyPak cartridge is not installed correctly or not installed at all.</li> </ul>	<ul style="list-style-type: none"> <li>• Reinstall the SynergyPak cartridge.</li> <li>• If the red Pack Alarm is still displayed, then contact Millipore.</li> </ul>

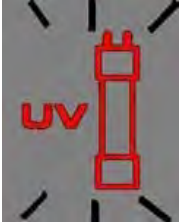
## Troubleshooting

Problem	Possible causes	What to do
	<ul style="list-style-type: none"> <li>The system may have been in STANDBY mode for a while.</li> <li>The Product resistivity is below the Resistivity Setpoint set in menu option C02.</li> </ul>	<ul style="list-style-type: none"> <li>Recirculate the water in the system. See <i>Section How to recirculate water manually before dispensing.</i></li> <li>Replace the SynergyPak cartridge. See <i>Section How to Replace the SynergyPak cartridge.</i></li> </ul>
 <p data-bbox="146 667 281 692">UV System only</p>	<ul style="list-style-type: none"> <li>The UV Timer is exhausted.</li> </ul>	<ul style="list-style-type: none"> <li>Replace the UV Lamp. See <i>Section How to Replace the UV Lamp (UV System only).</i></li> <li>After a new UV Lamp has been installed, reset the UV Timer. See <i>Section How to View or Reset the UV Lamp Timer (C03).</i></li> </ul>
 <p data-bbox="146 967 281 992">UV System only</p>	<ul style="list-style-type: none"> <li>The UV Lamp is not installed correctly or not installed at all.</li> </ul>	<ul style="list-style-type: none"> <li>Power OFF the system and reinstall the UV Lamp.</li> <li>If the red UV Lamp Alarm is still displayed, then contact Millipore.</li> </ul>

**Catalogue Numbers for Synergy Systems**

For 230 VAC, 120 VAC, 100 VAC:

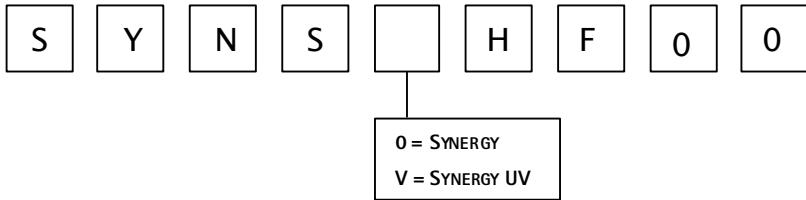

**Catalogue Numbers for Consumables**

Consumable Item	Catalogue Number
SynergyPak 1	SYPK0SIA1
SynergyPak 2	SYPK0SIX2
SynergyPak 3	SYPK0SIX3
Millipak Express 20 (Non-Sterile) – 1/box	MPGP02001
BioPak Ultrafiltration Cartridge	CDUFBI001
EDS-Pak® Final Filter	EDSPAK001
VOC-Pak™ Final Filter	VOCPAK001
EDS-Pak Installation Kit - ordered 1 time only for multiple EDS-Pak uses.	EDSKIT001
UV Lamp 185 nm	ZLUVWPM01

**Catalogue Numbers for Accessories**

Accessory Item	Catalogue Number
Wall Mounting Bracket	WMBSMT002
Pressure Regulator	ZFMQ000PR

## Quick access to most common procedures

Checking water quality.....	25
Contacting Millipore.....	2
Delivering a fixed ultrapure water volume.....	21
Delivering ultrapure water.....	21
Improving ultrapure water quality by recirculation before sourcing water.....	25
Replacing the Millipak end filter.....	31
Replacing the SynergyPak.....	28
Replacing the UV lamp.....	33
Review on-line e-learning on how to use & maintain the system.....	2



FTP09574